

# Rowenta

E F F E C T I V E

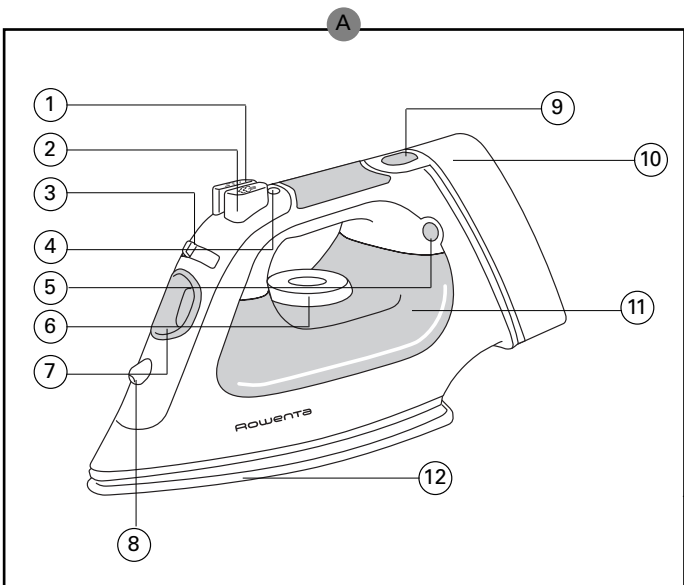

**A**

## Appliance description

- |   |  |
|---|--|
| 1 Spray button                                    | 7 Water filling inlet                            |
| 2 Burst of steam and vertical steam button        | 8 Spray nozzle                                   |
| 3 Variable steam control with Self Clean Function | 9 Release button                                 |
| 4 Auto-off light                                  | 10 Cord reel                                     |
| 5 Thermostat light                                | 11 Water tank with maximum water level indicator |
| 6 Temperature control dial                        | 12 Soleplate                                     |

## IMPORTANT SAFETY INSTRUCTIONS

When using your iron, basic safety precautions should always be followed, including the following :

Read all instructions before using the iron.

- Use iron only for its intended use.
- To protect against a risk of electric shock, do not immerse the iron in water or other liquids.
- The iron should always be turned to Minimum (Min) before plugging or unplugging from outlet. Never yank cord to disconnect from outlet, instead grasp plug and pull to disconnect.
- Do not allow cord to touch hot surfaces. Let iron cool completely before putting away. Loop cord loosely around iron when storing.
- Always disconnect iron from electrical outlet when filling iron with water, emptying iron or when not in use.
- Do not operate iron with a damaged cord or if the iron has been dropped or damaged. To avoid the risk of electric shock, do not disassemble the iron, ship it to the nearest authorized Rowenta Appliance Service Center for examination and repair. Incorrect reassembly can cause a risk of electric shock when the iron is used.
- Close supervision is necessary for any appliance being used by or near children. Do not leave iron unattended while plugged in or on an ironing board.
- Burns can occur from touching hot metal parts, hot water or steam. Use caution when you turn a steam iron upside down there may be hot water in the reservoir.
- The use of accessory attachments is not recommended by Rowenta Appliance Company and may result in fire, electric shock or personal injury.

## SPECIAL INSTRUCTIONS

1. This is either a 1500 / 1600 watt appliance. To avoid an overload, do not operate another high wattage appliance on the same circuit.
2. If an extension cord is absolutely necessary, the marked electrical rating of the extension cord should be at least as great as the electrical rating of the appliance. Cords rated for less amperage may overheat. Care should be taken to arrange the cord so that it cannot be pulled or tripped over.
3. Your Rowenta appliance is intended for household or professional use.

## SAVE THESE INSTRUCTIONS

## Before Use

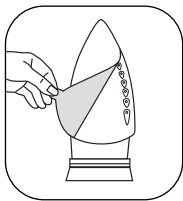

- Please read all of the Instructions for Use and the Important Safety Guards carefully.
- Remove all packaging from the iron.
- Remove the soleplate protector.
- It is normal for a small amount of smoke and a light odor to be produced the first time it is used. This will quickly disappear.
- Particles may emit from iron during first use. They are not harmful and should disappear after the iron has been allowed.

## Helpful Hints

- When ironing, start with fabrics that require a low temperature setting (●) and finish with those which need the highest temperature (●●●).
- Mixed fiber fabrics should be ironed on the temperature for the most delicate fabrics. For example a shirt that is 60 % cotton and 40 % polyester should be ironed at the (●) setting for synthetics.
- If spray starch is used, spray it onto the reverse side of the garment. Allow starch to penetrate before ironing by setting garment aside for 30 seconds.
- For best results, use a mesh type ironing board to allow excess steam to escape.
- For delicate fabrics, we recommend carrying out a test on an unobtrusive area of the garment such as an inner seam.
- Adhere to manufacturer recommendations on garment label.

## 3 Way Auto-Off

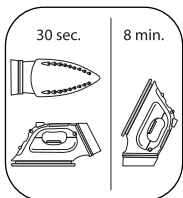

- If the iron is not moved while it is plugged in, an internal safety switch will turn it off.
- It will turn off in 8 minutes if left vertically or in 30 seconds if left on its soleplate or tipped over. A red flashing light indicates that the auto-off has been activated.
- To switch the iron on again, move the iron or gently shake it.

**Auto off is not on/off switch.**

**Always unplug iron when it is not use.**

## Filling with Water

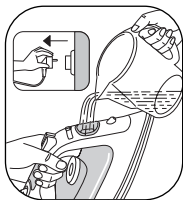

- Ensure the iron is unplugged.
- Slide the variable steam control completely to the left.
- Rest the iron on heel and tilt it forward approximately 1 inch. If the iron is equipped with a covered filling inlet, open the filling inlet by sliding the cover down.
- Hold the appliance upright so that the water inlet is horizontal.
- Fill with water (containing no additives) to the max mark on the water tank. We recommend using water pitcher rather than filling under the tap.
- If you need to add water during ironing, UNPLUG the iron and follow the steps above.
- Ensure iron heats back to temperature afterwards, that means thermostat light will go out.

## Water Recommendations

### Tap water

Rowenta irons are designed to be used with REGULAR TAP WATER (up to 12 grains of hardness). If your water is harder than this, Rowenta recommends mixing half tap water with half distilled water which reduces the hardness; or just use inexpensive bottled spring water. Never use 100% distilled water since this can cause the iron to spit and leak.

### Softened water

There are many types of household water softeners and the water from many of them is perfectly acceptable for use in an iron. However, some types of softeners, particularly those that use chemicals such as salt, can cause the iron to leak or spit during use. If you experience this type of problem, we recommend that you try using inexpensive bottled spring water or untreated tap water. Never use 100% pure distilled water.

Once you have changed water it will take several uses to correct the problem. Rowenta recommends trying the steam function for the first time on an old towel or cloth to avoid damaging your clothes.

### Iron and other impurities

If your water supply contains large amounts of iron or organic matter, these minerals can collect inside the iron and eventually appear as brown stains. If you experience these problems Rowenta recommends using inexpensive bottled spring water. Never use 100% pure distilled water

### Always remember:

Battery water and water containing additives (such as starch, perfume or fabric conditioner) may not be used. Such additives can affect the properties of the steam and, at high temperatures, can form deposits in the steam chamber, which will mark the laundry when they are emitted through the steam vents.

**For this reason descaling liquids should not be used.**

## Selecting the Temperature

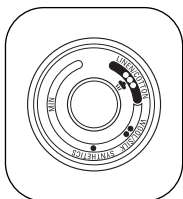

- Set the temperature control dial according to the fabric you are ironing. Check the garments label for appropriate setting. We recommend using the chart below as a guide.

Ironing label	Fabric	Temperature control
	Synthetic fibres e.g. viscose, polyester	●
	silk, wool	● ●
	cotton, linen	● ● ●

Light will be on as iron is heating. When light goes out iron is ready to use. When heating a cold iron, please allow thermostat to cycle twice before use (thermostat light will go on and off twice).

## Steam Ironing

### WARNING !

- Never iron or steam clothes while they are being worn.
- Before ironing for the first time fill iron and allow to heat.
- The iron should be allowed to emit steam for 1 to 2 minutes while pressing the burst of steam button a few times to remove any impurities. This should also be done if iron is not used regularly.

Steam is only produced when the temperature dial is set to the shaded area (after ●● setting).

### Burst of steam

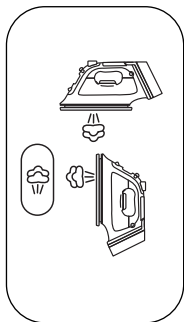

- This feature is ideal for removing stubborn wrinkles or pressing in sharp creases in horizontal use. When the temperature control is set to the steam zone (after ●●) the burst of steam can be used by pressing the burst of steam button. Leave an interval of 4 seconds between bursts.

### Vertical Steam

- The iron can also be used vertically.
- This is especially useful for getting creases out of hanging clothes, curtains, tapestries, etc.
- To steam vertically, press the burst of steam button while holding iron in the upright position.

**Warning! Never iron clothes while they are being worn.**

## Dry Ironing

- To iron without steam, slide the variable steam control lever to the ☁ position.
- We recommend dry ironing with an empty tank.
- Set the temperature for the type of material to be ironed (●, ●● or ●●●).

## Steam ironing\*



- You can steam iron by setting the temperature in the marked steam zone (after ●●). The steam quantity can be set to between ☁ (no steam position) and ☁ (maximum steam quantity). We recommend setting to maximum steam quantity only when the iron is set at temperature setting ●●●.

## Auto Steam\*



- For steam output to be automatically adjusted to the soleplate temperature, turn the steam control to the ☁  
AUTO position.

\* Depending on model

## Spray Setting

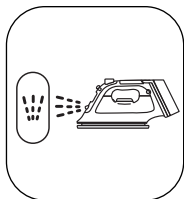

- This feature is ideal for stubborn wrinkles or set in creases.
- Ensure there is water in the tank then press the spray button.
- Do not spray silk.

## Anti-Drip System

- In order to produce steam, all irons require a high temperature. If the soleplate is not hot enough some of the water will not turn to steam and can spit or leak from the soleplate. The Anti-Drip system automatically switches off the steam when ironing at low temperatures to prevent spitting.

## Anti-Calc System

- Minerals in water can build up in the steam chamber. The Anti-Calc system contains a special material that neutralizes the harmful minerals. This system is designed to extend and maintain the high steam performance of the iron. The cartridge is not replaceable.

## Self Clean

**Warning! Do not use descaling agents. They can damage the lining of the steam chamber.**

This feature allows loose mineral deposits and other impurities to be flushed from the soleplate.

Self Clean should be carried out occasionally and at least once a month.

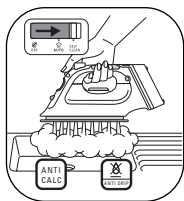

- Fill the iron with tap water to the max mark on the water tank.
- Be sure that variable steam lever is set to minimum.
- Stand the iron on heel and plug in.
- Set thermostat to ●●● setting.
- Once heated, unplug iron.
- Hold iron horizontally over the sink with the soleplate pointing away from body.
- Move the variable steam lever completely to the right and hold in the self clean position for one minute.

**Warning! Doing this will cause steam and hot water to be ejected from the soleplate. Take all proper precautions and hold iron away from body.**

- Move the iron gently back and forth and side to side until all water has run through plate.
- Carefully wipe all water and material from the soleplate with an old towel, as the water and minerals can stain the soleplate (although this has no effect on glide of performance).

**Warning! Iron and soleplate may still be very hot. Exercise care while wiping.**

- Place iron on heel and leave to cool.

Before using iron after self cleaning, test steam and burst of steam on an old towel or cloth than can be discarded.

## **Vapodur Valve**

To ensure the iron continues to steam efficiently, open and close the valve a few times after each use. This is done by moving the variable steam control lever left to right a few times.

## **After Ironing**

1. Turn temp dial to min. setting and then unplug the iron. Slide the variable steam control completely to the left (min. setting) and empty any water left in the tank. Leave the iron to cool down.
2. Hold end of cord at plug to slowly guide cord back into reel. Press cord reel button to retract cord for storage.
3. Store iron on heel (vertically) with steam control lever set to min.

## **Cleaning and Maintenance**

When cold and unplugged, the iron can be cleaned with a damp cloth and wiped dry.

Never use household cleaners or solvents.

### **Cleaning the soleplate**

Rowenta soleplates have excellent non-stick properties and can be wiped clean when cold.

- In normal use a draggy coating may build up on the soleplate (starch, detergent build-up, burnt synthetic fibers). This can easily be removed by using the Rowenta Soleplate Kit or a quality hot iron soleplate cleaner available at most stores. The Rowenta kit is also available through our website: [www.rowentausa.com](http://www.rowentausa.com).
- To prevent scratching of the soleplate, do not iron over sharp objects (zippers, etc.). Do not place the iron on rough surfaces, e.g. metal iron support, which may scratch the soleplate.

## Troubleshooting

Issues	Possible causes	Solutions
Iron does not heat.	No properly plugged in.	Check that iron is plugged correctly.
	The temperature control is set too low.	Set the temperature control to a higher temperature.
	Auto-off has engaged (depending on model).	Move iron or shake it gently to reactivate.
Not enough steam.	There is insufficient water in the tank.	Fill the water tank.
	Iron is not set to a steam setting.	See section called "Steam Ironing"
	The Anti-drip function is active.	Wait for the soleplate to reach the correct temperature.
Iron is emitting a brown or white substance.	Water may need to be changed due to hardness or organic matter.	See section "Water recommendations" Switch to spring water or mix tap water with distilled water.
	Garment has not been rinsed sufficiently	Ensure garments are rinsed thoroughly to remove any detergent deposits or chemicals on new garments.
Iron is leaking.	Over use of burst button.	Allow mor time between each burst.
	Distilled or softened water being used.	See section "Water recommendations" Switch to spring water or mix tap water with distilled water.
	Overfilled.	Do not fill past max line on tank. Be sure to close the cover at filling inlet.
The Auto-off light is flashing.	Auto-off has engaged (depending on model).	Move iron or shake gently to reactivate.
Build up on the soleplate.	Starch use.	Spray reverse side of fabric and allow starch to penetrate.
	Burnt material. Ironing at too high temperature.	Be sure to set temperature according to fabric being ironed.
Spray function does not work.	Priming may be necessary on first use.	Fill with water. Hold cold iron horizontally. Place finger over the spray nozzle to create a vacuum. Press the spray button 4 to 5 times. Remove finger from nozzle, press spray button a few more times.

**If troubleshooting does not assist, before consulting the retailer regarding their return / exchange policy, please telephone consumer service at: 781-396-0600.**



In the interest of improving products, Rowenta reserves the right to change specifications without prior notice.

### LIMITED WARRANTY

All Rowenta products are warranted for 1 year from date of purchase against defects in material and workmanship. During this period, any Rowenta product that, upon inspection by Rowenta, is proved defective, will be repaired or replaced, at Rowenta's option, without charge to the customer. If a replacement product is sent, it will carry the remaining warranty of the original product. This warranty does not apply to any defect arising from a buyer's or user's misuse of the product, negligence, failure to follow Rowenta's instructions, use on current or voltage other than stamped on the product or alteration or repair not authorized by Rowenta. Repair or disassembly by anyone other than a Rowenta authorized service center will void the warranty. THE WARRANTIES SET FORTH HEREIN ARE EXCLUSIVE AND NO OTHER WARRANTIES, EXPRESS OR IMPLIED, INCLUDING BUT NOT LIMITED TO ANY WARRANTY OF MERCHANTABILITY OR FITNESS FOR A PARTICULAR PURPOSE OR USE, ARE MADE BY ROWENTA OR ARE AUTHORIZED TO BE MADE WITH RESPECT TO THE PRODUCT. If you believe your product is defective, bring the product (or send it, postage prepaid) along with proof of purchase to the nearest authorized Rowenta Service Center (see below). If you send the product, please include a letter explaining the nature of the claimed defect. Rowenta 196 Boston Avenue Medford, MA 02155 U.S.A. Tel.: (781)396-0600 [www.rowentausa.com](http://www.rowentausa.com) OFFICE LOCATION ONLY. If your appliance needs service, ship the product to your nearest regional service center. Be sure to put your name on outside of shipping box (no P.O. boxes please). If in warranty, Rowenta will repair or replace product at their discretion. If the product is out of warranty, you will be advised of the cost of repair before any work begins. Our main service centers are listed below. Turnpike Appliance Authorized Appliance 3495A Lawson Blvd. 1644 West Ogden Ave. Oceanside, NY 11572 Downers Grove, IL 60515 516-483-5596 630-852-1550 Service

## Rowenta

196 Boston Avenue  
Medford, MA 02155  
Tel. : (781) 396-0600  
www.rowentausa.com

### OFFICE LOCATION ONLY.

To service product see service center information below.

If your appliance needs service, ship the product to your nearest regional service center. Be sure to put your name on the outside of shipping box (no P.O. boxes please). If in warranty, Rowenta will repair or replace product at their discretion. If the product is out of warranty you will be advised of the cost of repair before any work begins.

Our main service centers are listed below :

Turnpike Appliance  
3495A Lawson Blvd.  
Oceanside, NY 11572  
516-483-5596

Authorized Appliance  
1644 West Ogden Ave.  
Downers Grove, IL 60515  
630-852-1550

**Service center information is subject to change.** Please visit our website at [www.rowentausa.com](http://www.rowentausa.com) or call our **service center information line** at 781-306-4620. The information line provides current service center information and listings in California.